

Pressure transmitter For general industrial applications Model A-10



for further approvals
see page 9

Applications

- Machine building
- Shipbuilding
- Measurement and control technology
- Hydraulics and pneumatics
- Pumps and compressors

Special features

- Measuring ranges from 0 ... 0.05 to 0 ... 1,000 bar
- Non-linearity 0.25 % or 0.5 %
- Output 4 ... 20 mA, DC 0 ... 10 V, DC 0 ... 5 V and others
- Electrical connection: Angular connector form A and C, circular connector M12 x 1, cable outlet 2 m
- Process connection G ¼ A DIN 3852-E, ¼ NPT and others



Pressure transmitter, model A-10

Description

The model A-10 pressure transmitter for general industrial applications is not only notable for its compact design, but it also offers excellent quality at an extremely competitive price.

The user can choose between a non-linearity of 0.25 % and 0.5 %. A free test protocol provides information on the measuring points recorded during manufacture.

The model A-10 is set up for worldwide use through the international cULus and EAC certification. The various pressure units and process connections required for particular operating conditions are available at short notice.

Measuring ranges

Gauge pressure								
bar	Measuring range	0 ... 0.05	0 ... 0.1	0 ... 0.16	0 ... 0.25	0 ... 0.4	0 ... 0.6	0 ... 1
	Overload safety	0.2	0.2	1	1	1	3	3
	Measuring range	0 ... 1.6	0 ... 2.5	0 ... 4	0 ... 6	0 ... 10¹⁾	0 ... 16¹⁾	0 ... 25¹⁾
	Overload safety	3.2	5	8	12	20	32	50
	Measuring range	0 ... 40	0 ... 60	0 ... 100	0 ... 160	0 ... 250	0 ... 400	0 ... 600
	Overload safety	80	120	200	320	500	800	1,200
	Measuring range	0 ... 1,000						
Overload safety	1,500							
inWC	Measuring range	0 ... 20	0 ... 40	0 ... 60	0 ... 80	0 ... 100	0 ... 120	0 ... 150
	Overload safety	84	84	400	400	400	400	400
	Measuring range	0 ... 200	0 ... 250	0 ... 400				
	Overload safety	400	1,200	1,200				
psi	Measuring range	0 ... 1	0 ... 5	0 ... 15	0 ... 25	0 ... 30	0 ... 50	0 ... 100
	Overload safety	3	14.5	45	60	60	100	200
	Measuring range	0 ... 160¹⁾	0 ... 200¹⁾	0 ... 300¹⁾	0 ... 500	0 ... 1,000	0 ... 1,500	0 ... 2,000
	Overload safety	290	400	600	1,000	1,740	2,900	4,000
	Measuring range	0 ... 3,000	0 ... 5,000	0 ... 10,000				
Overload safety	6,000	10,000	17,400					

1) If the medium water is measured, a higher overload safety is recommended.

Absolute pressure								
bar	Measuring range	0 ... 0.1	0 ... 0.16	0 ... 0.25	0 ... 0.4	0 ... 0.6	0 ... 1	0 ... 1.6
	Overload safety	1	1	1	1	3	3	3.2
	Measuring range	0 ... 2.5	0 ... 4	0 ... 6	0 ... 10	0 ... 16	0 ... 25	
	Overload safety	5	8	12	20	32	50	
inWC	Measuring range	0 ... 40	0 ... 60	0 ... 80	0 ... 100	0 ... 120	0 ... 150	0 ... 200
	Overload safety	400	400	400	400	400	400	400
	Measuring range	0 ... 250	0 ... 400					
	Overload safety	1,200	1,200					
psi	Measuring range	0 ... 5	0 ... 15	0 ... 25	0 ... 30	0 ... 50	0 ... 100	0 ... 150
	Overload safety	14.5	45	60	60	100	200	290
	Measuring range	0 ... 200	0 ... 300					
	Overload safety	400	600					

Vacuum and +/- measuring range						
bar	Measuring range	-0.025 ... +0.025	-0.05 ... 0	-0.05 ... +0.05	-0.05 ... +0.15	-0.05 ... +0.2
	Overload safety	±0.2	±0.2	±0.2	1	1
	Measuring range	-0.05 ... +0.25	-0.1 ... 0	-0.1 ... +0.1	-0.15 ... +0.15	-0.16 ... 0
	Overload safety	1	±0.2	1	1	1
	Measuring range	-0.2 ... +0.2	-0.25 ... 0	-0.25 ... +0.25	-0.3 ... +0.3	-0.4 ... 0
	Overload safety	1	1	1	3	1
	Measuring range	-0.5 ... +0.5	-0.6 ... 0	-1 ... 0	-1 ... +0.6	-1 ... +1.5
	Overload safety	3	3	3	3.2	5
	Measuring range	-1 ... +3	-1 ... +5	-1 ... +9¹⁾	-1 ... +15¹⁾	-1 ... +24¹⁾
Overload safety	8	12	20	32	50	
inWC	Measuring range	-10 ... +10	-20 ... 0	-20 ... +20	-40 ... 0	-40 ... +40
	Overload safety	±80	±80	±80	±80	±80
	Measuring range	-50 ... +50	-60 ... 0	-75 ... +75	-80 ... 0	-100 ... 0
	Overload safety	400	400	400	400	400
	Measuring range	-100 ... +100	-120 ... 0	-125 ... +125	-150 ... 0	-200 ... +200
	Overload safety	400	400	1,200	400	1,200
	Measuring range	-250 ... 0				
Overload safety	1,200					
psi	Measuring range	-1 ... 0	-30 inHg ... 0	-30 inHg ... +15	-30 inHg ... +30	-30 inHg ... +60
	Overload safety	±3	45	60	60	150
	Measuring range	-30 inHg ... +100	-30 inHg ... +160¹⁾	-30 inHg ... +200¹⁾	-30 inHg ... +300¹⁾	
	Overload safety	250	350	450	600	

1) If the medium water is measured, a higher overload safety is recommended.

The given measuring ranges are also available in mbar, kg/cm², MPa and kPa.

Other measuring ranges available on request.

3-fold overload safety available on request.

Vacuum tightness

Yes (for restrictions see overload safety)

Output signals

Output signals	
Current (2-wire)	4 ... 20 mA
Voltage (3-wire)	DC 0 ... 10 V
	DC 0 ... 5 V
	DC 1 ... 5 V
	DC 0.5 ... 4.5 V
Ratiometric (3-wire)	DC 0.5 ... 4.5 V

Other output signals on request

Load in Ω

Current (2-wire): $\leq (\text{power supply} - 8 \text{ V}) / 0.02 \text{ A}$

Voltage (3-wire): $> \text{maximum output signal} / 1 \text{ mA}$

Ratiometric (3-wire): $> 10 \text{ k}$

Voltage supply

Output signal	Power supply	
	Standard	Option
4 ... 20 mA	DC 8 ... 30 V	DC 8 ... 35 V ¹⁾²⁾
DC 0 ... 10 V	DC 14 ... 30 V	DC 14 ... 35 V
DC 0 ... 5 V ³⁾	DC 8 ... 30 V	DC 8 ... 35 V
DC 1 ... 5 V	DC 8 ... 30 V	DC 8 ... 35 V
DC 0.5 ... 4.5 V	DC 8 ... 30 V	DC 8 ... 35 V
DC 0.5 ... 4.5 V ratiometric	DC 5 V \pm 10 %	-

1) Not possible with non-linearity 0.25 % BFS

2) Only possible for temperatures up to 80 °C (176 °F)

3) Not possible with measuring ranges $\leq 0.1 \text{ bar}$ (or equivalent)

The power supply for the pressure transmitter must be made via an energy-limited electrical circuit in accordance with section 9.3 of UL/EN/IEC 61010-1, or an LPS per UL/EN/IEC 60950-1, or class 2 in accordance with UL1310/UL1585 (NEC or CEC). The power supply must be suitable for operation above 2,000 m should the pressure transmitter be used at this altitude.

Total current consumption

Current (2-wire): Signal current, max. 25 mA

Voltage (3-wire): 8 mA

Ratiometric (3-wire): 8 mA

Accuracy specifications

Optionally the model A-10 is available with an improved non-linearity. Depending on the selected non-linearity the following values result:

	Standard	Option
Non-linearity per BFSL (IEC 61298-2)		
■ Measuring range ≤ 0.1 bar	$\leq \pm 0.5$ % of span	-
■ Measuring range > 0.1 bar	$\leq \pm 0.5$ % of span	$\leq \pm 0.25$ % of span ¹⁾
Measuring deviation of the zero signal ^{2) 3)}		
■ 4 ... 20 mA	$\leq \pm 0.3$ % of span	$\leq \pm 0.2$ % of span
■ DC 0 ... 10 V	$\leq \pm 0.5$ % of span	$\leq \pm 0.4$ % of span
■ DC 0 ... 5 V ⁴⁾	$\leq \pm 0.6$ % of span	-
■ DC 1 ... 5 V	$\leq \pm 0.3$ % of span	$\leq \pm 0.2$ % of span
■ DC 0.5 ... 4.5 V	$\leq \pm 0.3$ % of span	$\leq \pm 0.2$ % of span
■ DC 0.5 ... 4.5 V ratiometric	$\leq \pm 0.3$ % of span	$\leq \pm 0.2$ % of span
Accuracy at room temperature ⁵⁾		
■ Measuring range ≥ 0.6 bar	$\leq \pm 1$ % of span	$\leq \pm 0.5$ % of span
■ Measuring range ≥ 0.4 bar	$\leq \pm 1.2$ % of span	$\leq \pm 0.7$ % of span
■ Measuring range ≥ 0.25 bar	$\leq \pm 1.3$ % of span	$\leq \pm 0.8$ % of span
■ Measuring range ≥ 0.16 bar	$\leq \pm 1.5$ % of span	$\leq \pm 1$ % of span
■ Measuring range ≥ 0.1 bar	$\leq \pm 1.8$ % of span	-
■ Measuring range ≥ 0.05 bar	$\leq \pm 2.4$ % of span	-

In case of occasional faults due to electrostatic discharges, a temporary measuring error of up to ± 2.5 % can occur.

1) Not possible with output signal DC 0 ... 5 V

2) Measuring ranges ≤ 0.1 bar (or equivalent) only possible with $\leq \pm 0.5$ % of span.

3) Outside reference conditions the temperature hysteresis has to be added for measuring ranges < 0.6 bar.

4) Not possible with measuring range ≤ 0.1 bar (or equivalent)

5) Including non-linearity, hysteresis, zero offset and end value deviation (corresponds to measured error per IEC 61298-2), calibrated in vertical mounting position with process connection facing downwards

Non-repeatability (per IEC 61298-2)

Measuring range ≤ 0.1 bar: ≤ 0.2 % of span

Measuring range > 0.1 bar: ≤ 0.1 % of span

Signal noise

$\leq \pm 0.3$ % of span

($\leq \pm 0.2$ % of span on request)

Temperature error at 0 ... 80 °C (32 ... 176 °F)

Typical: $\leq \pm 1$ % of span

Maximum: $\leq \pm 2.5$ % of span

Maximum $\leq \pm 1.5$ % of span on request

Long-term drift (per IEC 61298-2)

Measuring ranges ≤ 0.1 bar: $\leq \pm 0.5$ % of span ¹⁾

Measuring ranges ≤ 0.4 bar: $\leq \pm 0.2$ % of span

Measuring ranges > 0.4 bar: $\leq \pm 0.1$ % of span

1) Outside reference conditions the temperature hysteresis has to be added for measuring ranges ≤ 0.1 bar.

Temperature hysteresis -30 ... +100°C (-22 ... +212 °F) for measuring ranges < 0.6 bar

Measuring range	Gauge pressure	Absolute pressure
≥ 0.40 bar	$\leq \pm 0.2$ % of span	$\leq \pm 0.2$ % of span
≥ 0.25 bar	$\leq \pm 0.3$ % of span	$\leq \pm 0.3$ % of span
≥ 0.16 bar	$\leq \pm 0.5$ % of span	$\leq \pm 0.5$ % of span
≥ 0.10 bar	$\leq \pm 0.7$ % of span	$\leq \pm 0.8$ % of span
≥ 0.05 bar	$\leq \pm 1.4$ % of span	-

Time response

Measuring range	Settling time	Switch-on time
≥ 0.4 bar	< 4 ms ¹⁾	< 15 ms
≥ 0.05 bar	< 1 min	< 1 min

1) 1 ms on request

Reference conditions (per IEC 61298-1)
Temperature

15 ... 25 °C (59 ... 77 °F)

Atmospheric pressure

860 ... 1,060 mbar (12.5 ... 15.4 psi)

Humidity

45 ... 75 % relative

Power supply

DC 24 V

Mounting position

as required

Operating conditions
Ingress protection (per IEC 60529)

see table "Specifications"

Vibration resistance

 10 g (IEC 60068-2-6, under resonance) ¹⁾

 20 g available on request ^{2) 3)}

1) With GL approval and measuring range 0 ... 0.6 bar only feasible with an accuracy of 1 %

2) With GL approval only feasible for measuring range > 0 ... 1 bar

3) From -30 °C (-22 °F)

Shock resistance

500 g (IEC 60068-2-27, mechanical)

100 g at -40 °C (-40 °F)

Service life

Measuring range > 0.1 bar: 100 million load cycles

Measuring range ≤ 0.1 bar: 10 million load cycles

Permissible temperature ranges

	Standard	Option	
		Voltage signal	Current signal ^{1) 2)}
Ambient	0 ... +80 °C (32 ... 176 °F)	-30 ... +100 °C (-22 ... +212 °F)	-40 ... +100 °C ³⁾ (-40 ... +212 °F)
Medium	0 ... +80 °C (32 ... 176 °F)	-30 ... +100 °C (-22 ... +212 °F)	-40 ... +100 °C ³⁾ (-40 ... +212 °F)
Storage	-40 ... +70 °C (-40 ... +158 °F)	-40 ... +70 °C (-40 ... +158 °F)	-40 ... +70 °C (-40 ... +158 °F)

Restrictions and derating of the ambient temperature depend on the medium temperature. Depending on the choice of sealing on the process connection, there may be limitations in the permissible temperature range (for limitations see "Process connections, sealings").

1) With cULus approval the minimum ambient and medium temperature is -30 °C (-22 °F)

2) Only with power supply DC 8 ... 30 V

3) Only with housed installation site that is protected from condensation

Process connections

Standard	Thread size
EN 837	G 1/8 B ¹⁾
	G 1/4 B
	G 1/4 female
	G 1/4 female, with flange connection ²⁾
	G 3/8 B
	G 1/2 B
DIN 3852-E ³⁾⁴⁾	G 1/4 A
	G 1/2 A
	M14 x 1.5
ANSI/ASME B1.20.1	1/8 NPT ¹⁾
	1/4 NPT
	1/4 NPT female
	1/2 NPT
DIN 16288	M20 x 1.5
ISO 7	R 1/4
	R 3/8
	R 1/2
KS	PT 1/4
	PT 1/2
	PT 3/8
SAE J514 E ³⁾⁴⁾	7/16-20 UNF O-ring BOSS

1) Maximum measuring range 400 bar

2) Maximum measuring range 100 bar

3) Maximum overload safety 600 bar

4) Maximum permissible temperature -20 ... +100 °C (-4 ... +212 °F)

Pressure port

	Pressure port	Possible process connections
Standard	3.5 mm	All
Option 1	0.6 mm	All male threads
Option 2	0.3 mm	All male threads
Option 3	6.0 mm	G 1/4 A and 1/4 NPT

Optionally a T-restrictor is possible for the following process connections:

- G 1/4 B
- G 3/8 B
- G 1/2 B
- M20 x 1.5

Sealings

For the process connections of the following standards the listed sealing materials are available.

Standard	Standard	Option
EN 837	Copper	Stainless steel
DIN 3852-E	NBR	FKM
DIN 16288	Copper	Stainless steel
SAE J514 E	NBR	FKM

The sealings listed under "Standard" are included in the delivery.

Electrical connections

Designation	Ingress protection ³⁾	Wire cross-section	Cable diameter	Cable material
Angular connector DIN 175301-803 A				
■ with mating connector	IP65	up to a max. 1.5 mm ²	6 ... 8 mm	-
■ with moulded cable	IP65	3 x 0.75 mm ²	6 mm	PUR
Angular connector DIN 175301-803 C				
■ with mating connector	IP65	up to a max. 0.75 mm ²	4.5 ... 6 mm	-
■ with moulded cable	IP65	4 x 0.5 mm ²	6.2 mm	PUR
Circular connector M12 x 1 (4-pin)				
■ without mating connector	IP67	-	-	-
■ straight with moulded cable	IP67	3 x 0.34 mm ²	4.3 mm	PUR
■ angled with moulded cable	IP67	3 x 0.34 mm ²	4.3 mm	PUR
Cable outlet				
■ unshielded ¹⁾	IP67	3 x 0.34 mm ²	4 mm	PUR
■ OEM version, unshielded ²⁾	IP67	3 x 0.14 mm ²	2.85 mm	TPU

1) Not feasible with GL approval

2) up to a max. 90 °C (194 °F)

3) The stated ingress protection (per IEC 60529) only applies when plugged in using mating connectors that have the appropriate ingress protection.

Mating connectors (with and without cable) are also separately available as accessories.

Cable lengths of 2 m or 5 m are available.

Short-circuit resistance

S+ vs. 0V

Reverse polarity protection

U_B vs. 0V

no reverse polarity protection with ratiometric output signal

Insulation voltage

DC 500 V

Connection diagrams

All connectors with moulded cable have the same colour assignment as the unshielded cable outlet.

Angular connector DIN 175301-803 A			
		2-wire	3-wire
	U _B	1	1
	0V	2	2
	S+	-	3

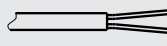
Cable outlet, unshielded			
		2-wire	3-wire
	U _B	brown	brown
	0V	blue	blue
	S+	-	black

Angular connector DIN 175301-803 C			
		2-wire	3-wire
	U _B	1	1
	0V	2	2
	S+	-	3

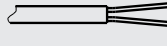
Cable outlet, OEM version, unshielded			
		2-wire	3-wire
	U _B	brown	brown
	0V	blue	blue
	S+	-	black

Circular connector M12 x 1 (4-pin)			
		2-wire	3-wire
	U _B	1	1
	0V	3	3
	S+	-	4

Legend

U_B Positive power supply terminal

0V Negative power supply terminal

S+ Analogue output

Materials

Wetted parts

- < 10 bar (150 psi): Stainless steel 316L
- ≥ 10 bar (150 psi): Stainless steel 316L and PH steel
- ≤ 0 ... 25 bar abs. (400 psia): Stainless steel 316L

Non-wetted parts

- Stainless steel 316L
- HNBR
- PA









For sealing materials see "Process connections"

For cable materials see "Electrical connections"

Pressure transmission medium

- < 0 ... 10 bar (150 psi): Synthetic oil
- ≤ 0 ... 25 bar abs. (400 psia): Synthetic oil
- ≥ 0 ... 10 bar (150 psi): Dry measuring cell

Approvals

Logo	Description	Country
	EU declaration of conformity <ul style="list-style-type: none"> ■ EMC directive ■ Pressure equipment directive ■ RoHS directive 	European Community
	UL ¹⁾ Safety (e.g. electr. safety, overpressure, ...)	USA and Canada
	EAC <ul style="list-style-type: none"> ■ Electromagnetic compatibility 	Eurasian Economic Community
	GOST Metrology, measurement technology	Russia
	KazInMetr Metrology, measurement technology	Kazakhstan
	MTSCHS Permission for commissioning	Kazakhstan
	BelGIM Metrology, measurement technology	Belarus
	UkrSEPRO Metrology, measurement technology	Ukraine
	Uzstandard Metrology, measurement technology	Uzbekistan
	DNV GL ¹⁾ Ships, shipbuilding (e.g. offshore)	Germany
	CRN Safety (e.g. electr. safety, overpressure, ...)	Canada

¹⁾ not for measuring ranges < 0.6 bar and not for medium temperature -40 ... +100 °C (-40 ... +212 °F)

Manufacturer's information and certifications

Logo	Description
-	MTTF: > 100 years
-	China RoHS conformity

Approvals and certificates, see website

Dimensions in mm

Pressure transmitter

with angular connector form A

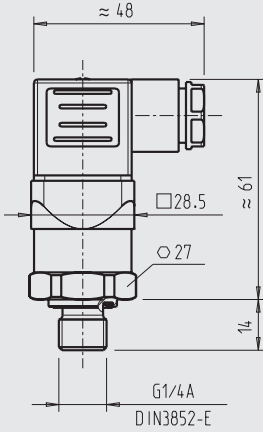

Weight: approx. 80 g

with angular connector form C

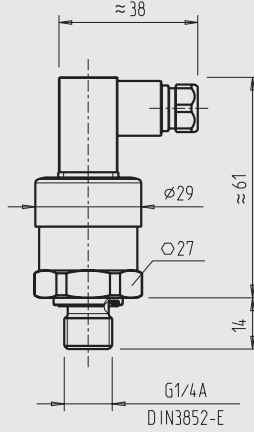

Weight: approx. 80 g

with angular connector form A and flange connection

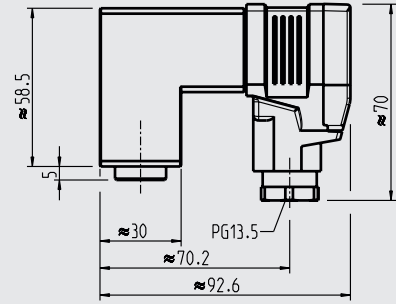

Weight: approx. 350 g

with M12 x 1 circular connector

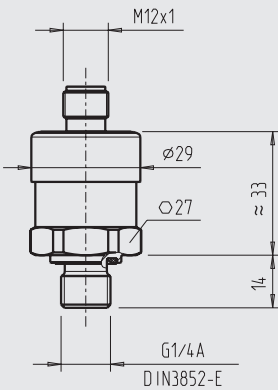

Weight: approx. 80 g

with standard cable outlet, unshielded

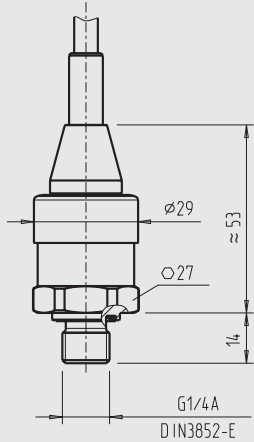

Weight: approx. 80 g

with cable outlet OEM version, unshielded

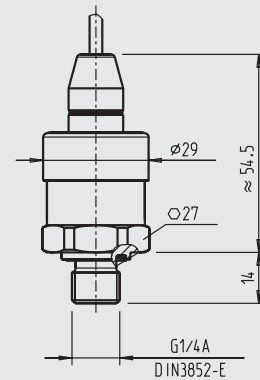

Weight: approx. 80 g

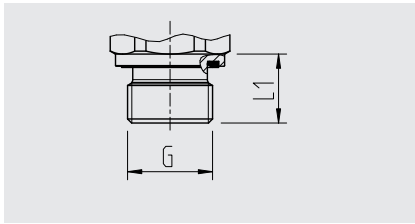
Process connections

G	L1
G ¼ A DIN 3852-E	14
G ½ A DIN 3852-E	17
M14 x 1.5	14

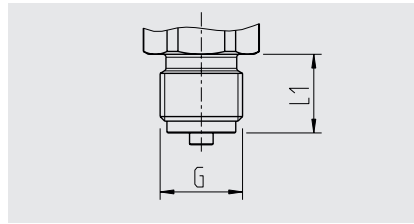

G	L1
G ¼ B EN 837	13
G ⅜ B EN 837	16
G ½ B EN 837	20
M20 x 1.5	20

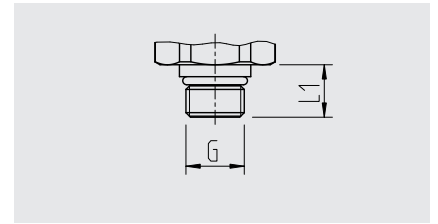

G	L1
7/16-20 UNF BOSS	12.85

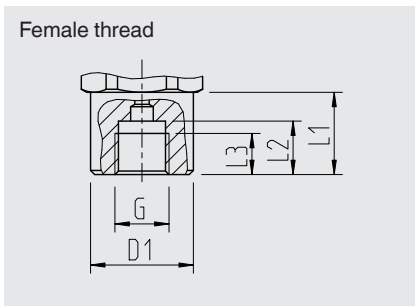

G	L1	L2	L3	D1
G ¼ EN 837	20	13	10	Ø 25

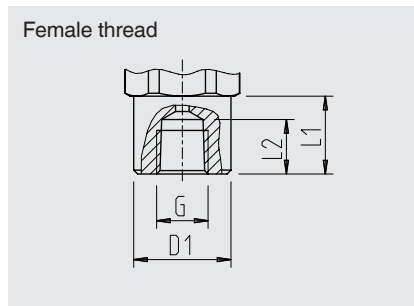

G	L1	L2	D1
¼ NPT	20	14	Ø 25

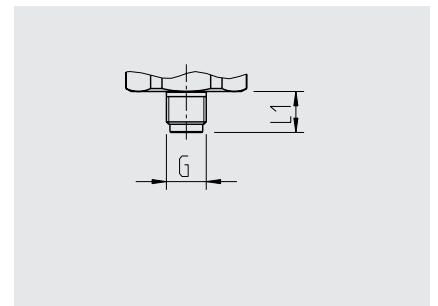

G	L1
G ⅜ B EN 837	10

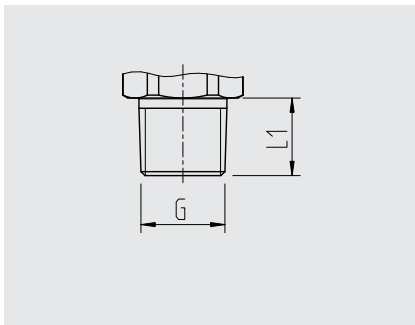

G	L1
⅛ NPT	10
¼ NPT	13
½ NPT	19
R ¼	13
R ⅜	15
R ½	19
PT ¼	13
PT ⅜	15
PT ½	19

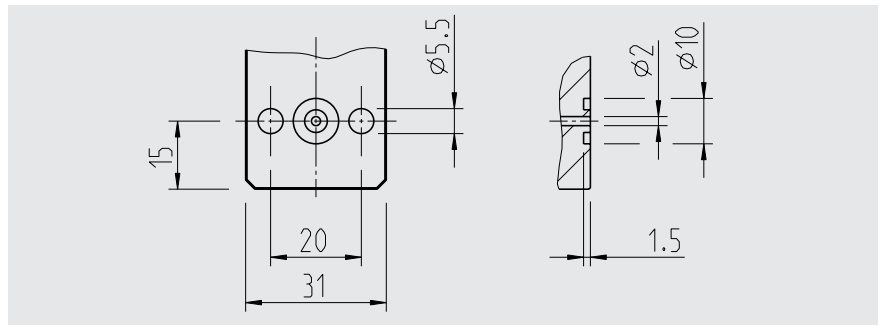

G ¼ female, with flange connection	For dimensions see drawing
------------------------------------	----------------------------

For information on tapped holes and welding sockets, see Technical information IN 00.14 at www.wika.com

Accessories and spare parts

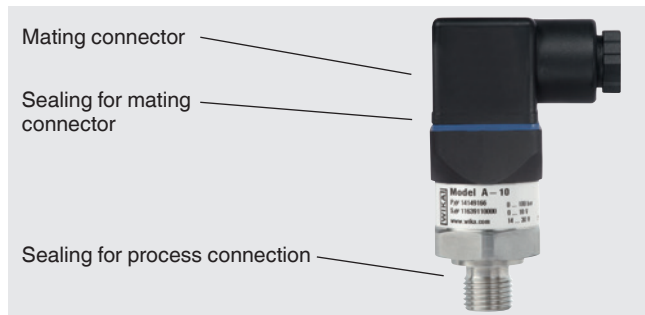

Mating connector

Designation	Order number		
	without cable	with 2 m cable	with 5 m cable
Angular connector DIN 175301-803 C	1439081 ¹⁾	11225823	11250194
Angular connector DIN 175301-803 A			
■ with cable gland, metric	11427567	11225793	11250186
■ with cable gland, conduit	11022485	-	-
Circular connector M12 x 1, 4-pin			
■ straight	2421262	11250780	11250259
■ angled	2421270	11250798	11250232

1) Connector not permissible for A-10 with GL approval

Sealings for mating connectors

Designation	Order number	
	Blue (WIKA)	Brown (neutral)
Angular connector DIN 175301-803 A	1576240	11437902
Angular connector DIN 175301-803 C	11169479	11437881

Sealings for process connection

Designation	Order number			
	Cu	Stainless steel	NBR	FKM
G ¼ EN 837	11250810	11250844	-	-
M14 x 1.5	-	-	1537857	1576534
G ½ EN 837	11250861	11251042	-	-
M20 x 1.5	11250861	11251042	-	-
G ⅝ EN 837	11251051	-	-	-
G ¼ DIN 3852-E	-	-	1537857	1576534
G ½ DIN 3852-E	-	-	1039067	1039075